



快速乾燥機系列

High Speed Dryer



燁品企業有限公司
YE PIN CO., LTD

目錄 Catalog

中文 Chinese	英文 English	頁數 Page
功能特色-4大提升	Feature-4 UPs	P2
功能特色-6大降低	Feature-6 Downs	P3
7大優勢結構	7 advantage structures	P4
乾燥效率比較	Compare Drying Efficiency	P5
含水率太高，對塑料的破壞	Water content rate is too high, it will be damage to plastic	P6
相對濕度、含水率、物性相互關係	Relationship between Relative humidity, Water content rate, Physical properties	P7
作動原理	What' s principle?	P8
化學吸附乾燥機 VS YP乾燥機	Chemical adsorption dryer VS YP Dryer	P9
第一回，省錢，省時，省電	Round One, SaveTime,Money,Electriciity	P10
第二回，結構	Round Two ,Structure	P12
第三回，環境	Round Three, Environment	P13
光學級快速乾燥機	Optics High Speed Dryer	P14

功能特色--4大提升

Features—4 Up



- 提高產品的抗拉性、抗破性、透光率、耐久性
- Increasing tensile resistance, fracture resistance, transparency, durability



- 提高成型品的良率及品質
- Increasing product validity and quality

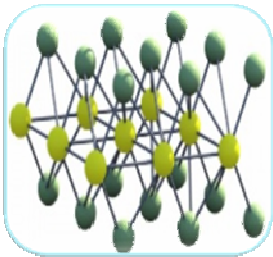

- 提高份子之間的連結
- Increasing molecule combination



- 提高生產的稼動率
- Increasing production mobility

功能特色--6大降低

Features--6 Downs



- 減少一半的烘料時間
- shorten half time of drying



- 降低含水率200 ppm以下
- Reducing water contain rate under 200ppm



- 降低烘料成本，節省電費40%以上
- Reducing electricity bill more than 40%



- 減少模具清洗的次數 (PA46,PPS)
- Reducing cleaning frequency of mold(PA46,PPS)



- 減少乾燥不完全所產生的不良(流紋、氣泡..等)
- Reducing defects of incomplete drying (such as streak, bubble....etc.)



- 降低原料成型時，經過料管高溫混煉的所產生的氣體
- Reducing the generation of gas during the injection molding

7大優勢結構

7 Structures

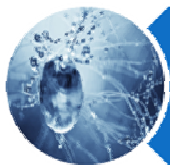

不用接冷卻水
No cooling water

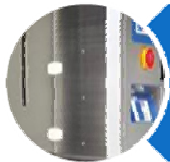

不銹鋼外殼易保養
Easy maintenance for
stainless steel case



集塵器
Dust Collector



LED微電腦式控制面板
LED microprocessor
controlled panel



功能均用燈號顯示
Light display function



機台可移動
Moveable



外罩式過濾器清理容易
Easy clean for outer
filters

- 多功能快速乾燥機搭配專利截料閥,使輸送管內的塑料不殘留,無塑料回潮的問題。
- Multi-function high speed dryer device is equipped with patented valve to completely clean the plastic residue such that there will be no plastic material re-dampening problem.

專利截料閥 Patented Valve



已申請多國專利結構
Multi-national patent
application structure

乾燥效率比較

Compare drying efficiency



效率佳
High
Efficiency

速度快
High
Speed

節能
Energy
Saving

YP 節省電費 40% ↑

YP save electricity 40% ↑

小時/hr ~若您想詢問其它材質的乾燥時間，歡迎與我們聯絡~
If you would like to know other plastic material drying time, please contact us directly.

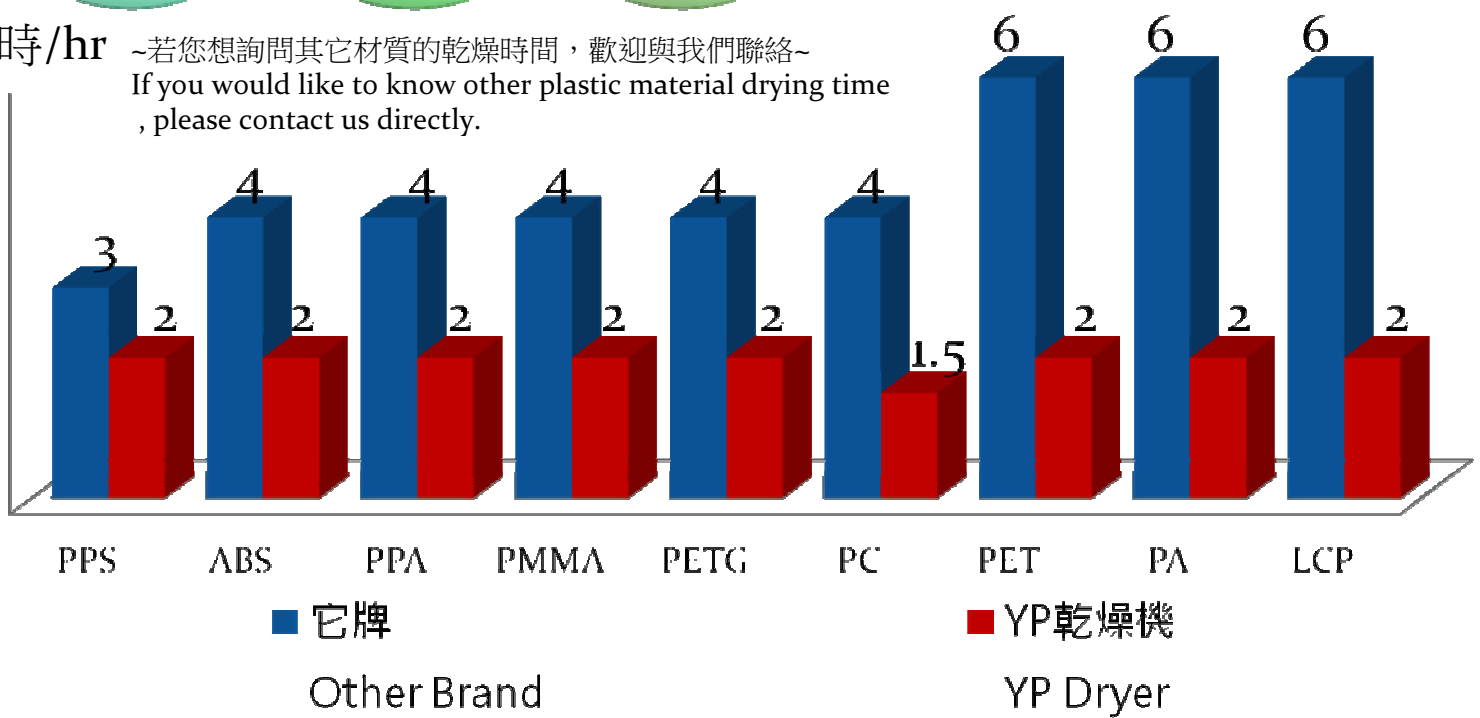

乾燥時間/小時 Drying Time / Hr	PPS	ABS	PPA	PMMA	PETG	PC	PET	PA	LCP
它牌 Other Brand	3	4	4	4	4	4	6	6	6
YP乾燥機 YP Dryer	2	2	2	2	2	1.5	2	2	2

含水率太高，對塑料之破壞

Water content rate is too high, it will be damage to plastic



若要生產高質量的塑膠製品必須先注意到 “前端塑料的乾燥處理”
If you would like to produce high quality plastics, you must be aware of “drying process before injection molding”.

相對濕度、含水率、物性相互關係

Relationship between Relative humidity, Water content rate, Physical properties



空氣中相對對濕度過高時，塑料就會快速吸濕，使塑料的含水率增加
 Relative humidity is too high in the air, plastic will humidify quickly, it will increase water content rate.

相對濕度%
 Relative humidity%

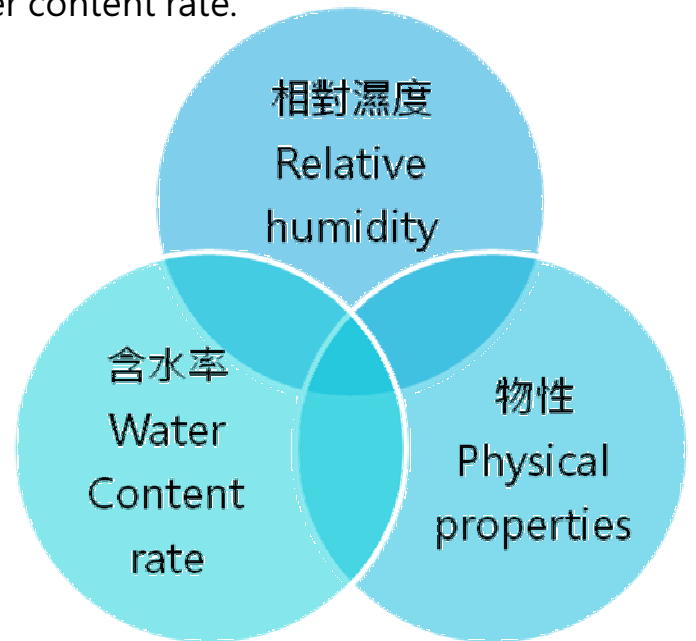
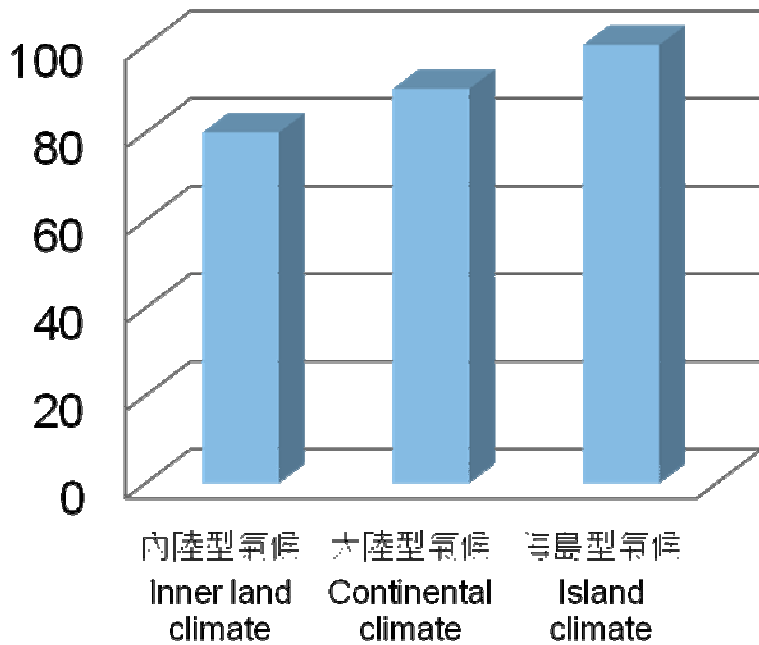

與最大值百分比
 Ratio to max bond %

含水率愈高，對物性的影響愈大
 High water content rate, it will have big influence to physical properties.

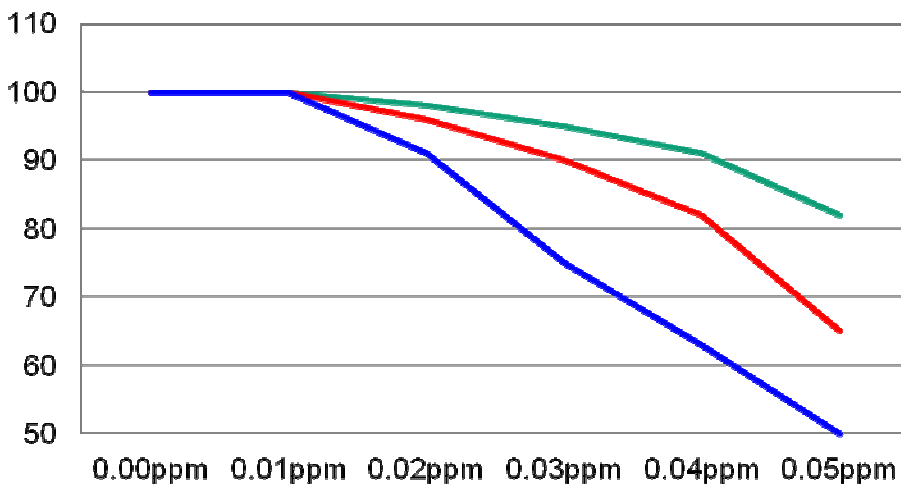

— 伸長強度
 Extension strength
 — 延伸率
 Extension rate

含水率
 Water content rate



作動原理?

What's principle?

低氣壓使水的沸點降低
Low pressure makes boiling point of water lower.

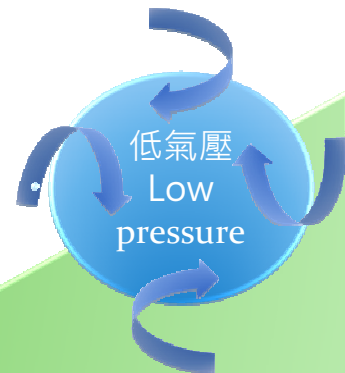

在喜馬拉亞山水的沸點是73°C
Boiling point of water in the Himalayas is 73°C.

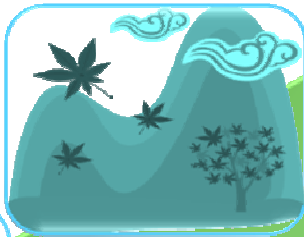

在高山水的沸點是80 °C~ 90°C
Boiling point of water in high mountain is 80 °C~ 90°C.

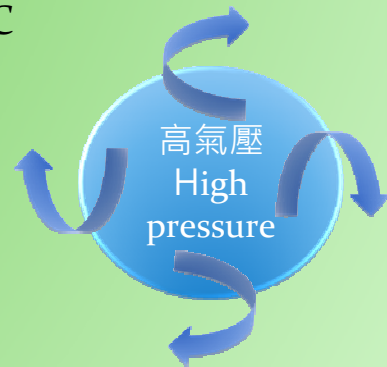

在平地水的沸點是100 °C
Boiling point of water on the ground is 100 °C.



燐品的快速乾燥機的乾燥原理，是用物理原理，非化學吸附。簡易的說：快速乾燥機將空氣吸入，產生低壓的氣流經過加熱，將乾燥的熱風打入料桶，將塑料中的水份子蒸發，(使露點的溫度達-40 °C 以下)。

Our High speed dryer uses "physical principle", not chemical absorbing. Let me explain to you: Air had been sucked by our high speed dryer, producing low pressure air, the low pressure air through heater. It becomes drying hot air into hopper to make moisture of plastic to vaporize.(reach dew point under -40°C)



化學吸附乾燥機

Chemical adsorption dryer

VS YP乾燥機

VS YP Dryer



VS



決戰三回合
Three round battle

第一回，省錢，省時，省電

Round One, Save Time, Money, Electricity

化學吸附乾燥機
Chemical adsorption dryer

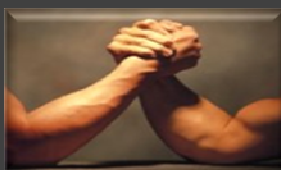

YP 乾燥機
YP dryer



額外的工程費用 Additional project costs

要接水管
Link water pipe



無
No



冷氣費用 Air-conditioning costs

要維持室內恆溫，
冷氣需持續的運作
In order to maintain the
indoor temperature, air-
conditioning needs to
continue operations



無
No



耗材費用 Consumables cost

高
High



低
Low



第一回，省錢，省時，省電

Round One, Save Time, Money, Electricity

化學吸附乾燥機
Chemical adsorption dryer



YP 乾燥機
YP dryer



乾燥時間
Clean room

如: PC要3~4小時
LCP要6~8小時

For example:
PC needs about 3~4
hours of drying time.
LCP needs about 6~8
hours of drying time.



如: PC要2小時
LCP要2小時

For example:
PC needs about 2 hours
of drying time.
LCP needs about 2 hours of
drying time.



耗電量
Power consumption

高耗電量

High power
Consumption.



低耗電量，約化學
吸附乾燥機的一半

Low power consumption,
power consumption is about
one half of chemical
adsorption dryer.



第二回，結構

Round Two, Structure

化學吸附乾燥機
Chemical adsorption dryer



YP 乾燥機
YP dryer



冷卻水 Cooling Water

要接冷卻水
It need to link cooling water.



不接冷卻水
No cooling water



外殼 Outer Case

白鐵烤漆，易掉漆生鏽
Painted iron, easy to peel off and get rusty.

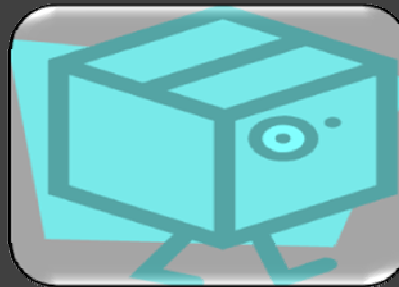

SUS304不銹鋼，
耐久不生鏽
SUS304
stainless steel,
durable and not
easy to rust.



分子篩 Molecular sieve

如:烘PA會出油，蜂巢和
分子篩會阻塞
For example: Drying PA
Will be out of oil.
Honeycomb and
molecular sieve will be
clogged.

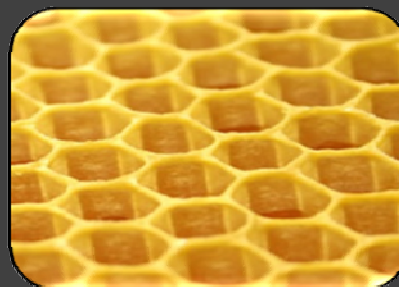

沒有分子篩，
具有專利機芯
結構，沒有阻
塞的疑慮
No molecular sieve, dryer
is equipped with patented
cassette mechanism
structure, no doubt for
clogging.



第三回，環境

Round Three, Environment



化學吸附乾燥機
Chemical adsorption dryer



YP 乾燥機
YP dryer



潔淨的無塵室 Clean room

接冷卻水，有漏水的可能性
It may leak water possibility, due to cooling water.



適用，無漏水的可能性
Suitable, no leaking water possibility.



熱氣排放 Exhausting hot air

會排出熱氣
It exhausts hot air.



無
No exhausting hot air.



光學級快速乾燥機

Optics High Speed Dryer



光學級乾燥機具有如下特點:

1. 吸料和送料
2. 除濕乾燥

Optics Dryer has below features:

1. Suction feeder and Autoloader
2. Dehumidifying



光學級快速乾燥機適用在高精密的工程塑料
如:光學級PC,光學級PET,光學級PMMA,等。

Optics high speed dryer is suitable for engineering plastics of high precision.

Such as PET, PMMA, PC of optics....ext.

光學級快速乾燥機-結構

Optics high speed dryer-Structure

空氣濾清器
Air Filter

空氣噴槍
Air spray gun

警報響起，請用空氣噴槍清潔
空氣濾清器即可。
Alarm will be buzzing, please
use air spray gun to clean air filter.

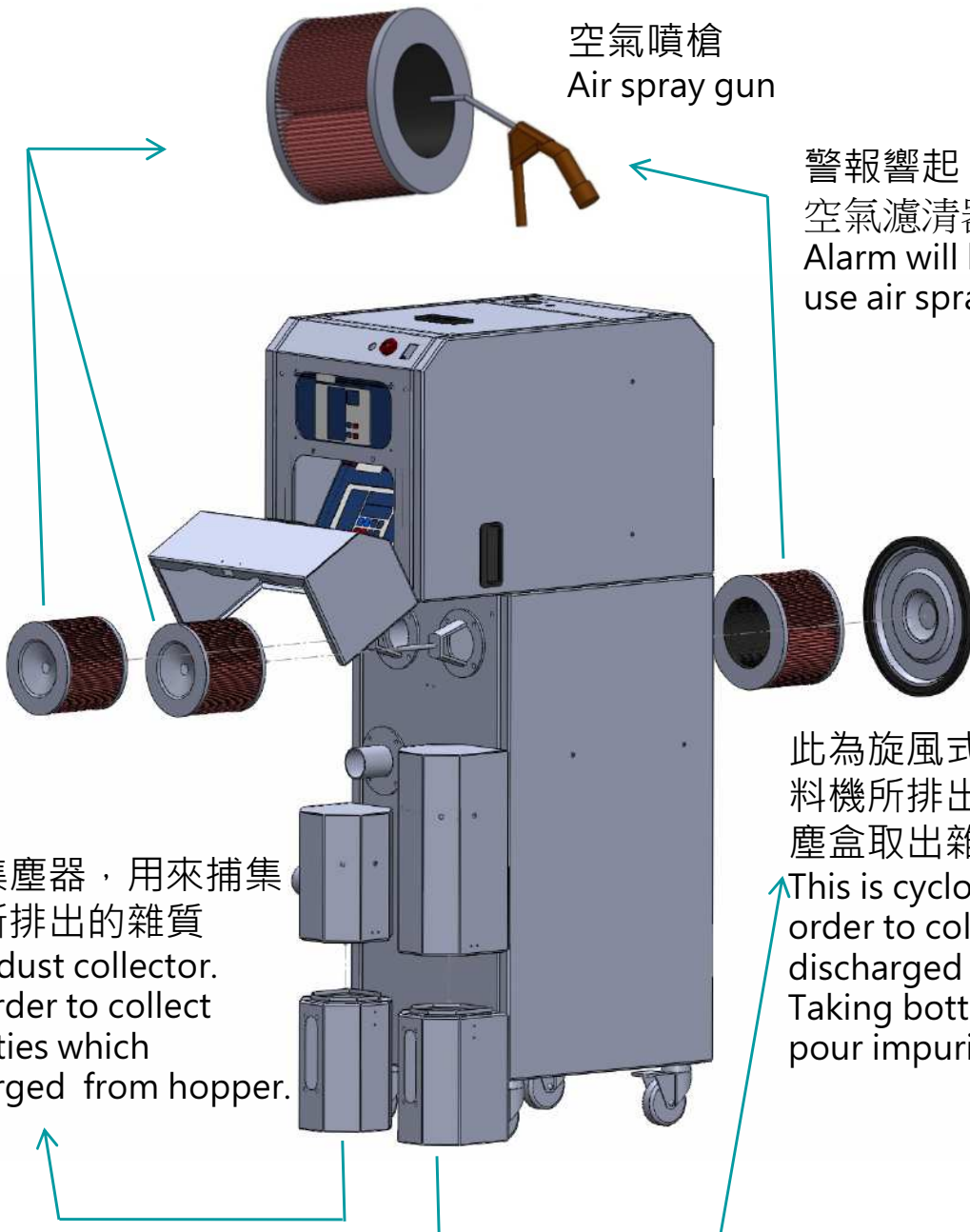

此為集塵器，用來捕集
料桶所排出的雜質
This is dust collector.
In to order to collect
impurities which
discharged from hopper.

此為旋風式集塵器，用來捕集吸
料機所排出的大雜質，將底部集
塵盒取出雜質倒掉即可。
This is cyclone dust collector. In
order to collect big impurities which
discharged from suction feeder.
Taking bottom dust collector to
pour impurities.

光學級快速乾燥機-示意圖

Optics high speed dryer-Schematic diagram

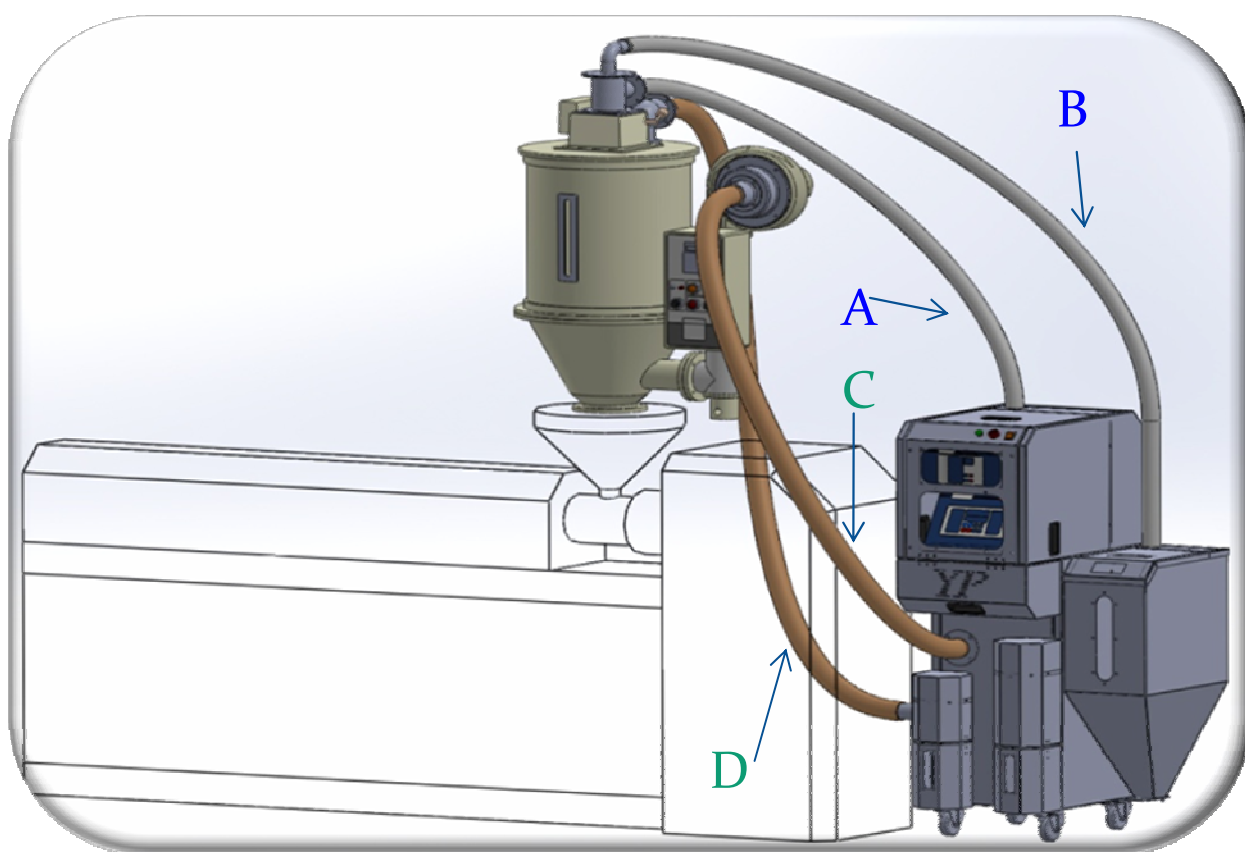

A: YP乾燥機吸風
A: Wind has been sucked by YP dryer.

B: 將塑料抽入料桶中
B: Plastic material send into hopper.

C: YP乾燥機將乾燥的風打入料桶中
C: YP dryer send drying wind into hopper.

D: 料桶中排放出的雜質送至YP集塵盒
D: Collecting impurities which discharged from hopper send into dust collector.

YP 快速乾燥機適用在各種射出機或押出機上
YP high speed dryer is suitable for all kinds of injection molding machine or extruder machine.



依客戶需求，乾燥機可搭配儲料桶，
報價不含儲料桶價格
Depend on customer demand, our
dryer could equipped with storage
can, price does not include storage
can price.



光學級快速乾燥機規格表

Optics High Speed Dryer Specification

型式 Model	HS-006OD	HS-015OD	HS-025OD	HS-050OD
入/回風管徑 (inch) inlet / outlet air pipe	2"	2"	2.5"	2.5"
電熱功率 (kw) Electric heating power	2.29	2.59	2.59	3.20
總瓦特數 (kw) Total wattage	2.95	3.25	3.40	3.70
送料風機 (kw) Feeder blower	0.75	0.75	0.75	0.75
尺寸 Size	寬度 Width (mm)	462	462	462
	深度 Depth (mm)	690	690	690
	高度 High (mm)	1330	1430	1430
重量 Weight(kg)	65	72	72.5	75

*此機台為連續式適用於所有塑料、生產用、實驗室

*This machine is continuous and suitable for all plastics ,production, and laboratory.

YP 快速乾燥機

YP High Speed Dryer

省錢 Save Money
快速 High Speed
節能 Save Energy

燁品企業有限公司
電話 : +886-3-409-0577
傳真 : +886-3-409-3381
網址 : www.ye-pin.com.tw
國內聯絡e-mail : yepin.com@msa.hinet.net
國外聯絡e-mail : service@ye-pin.com.tw

YE PIN CO., LTD.
TEL: +886-3-409-0577
FAX: +886-3-409-3381
Website : www.ye-pin.com.tw
Domestic contact e-mail: yepin.com@msa.hinet.net
Foreign contact e-mail: service@ye-pin.com.tw